

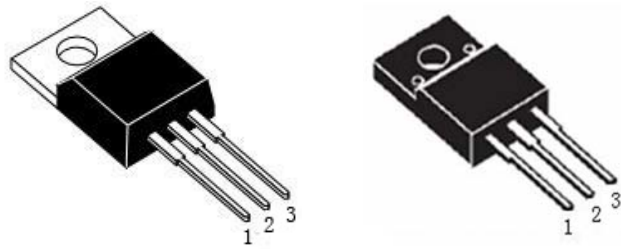

FEATURES

- * Schottky Barrier Chip
- * Guard Ring Die Construction for Transient Protection
- * Low Power Loss, High Efficiency
- * High Surge Capability
- * High Current Capability and Low Forward Voltage Drop
- * For Use in Low Voltage, High Frequency Inverters, Free Wheeling, and Polarity Protection Applications

PACKAGE



T0-220

1、 ANODE
2、 CATHODE
3、 ANODE

T0-220F

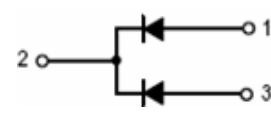

ELECTRICAL CHARACTERISTICS (Tamb=25°C)

Characteristic	Symbol	Value	Unit	
Peak Repetitive Reverse Voltage	V_{RRM}	45	V	
Working Peak Reverse Voltage	V_{RWM}			
DC Blocking Voltage	V_R			
Average Rectified Output Current	$I_{F(per\ leg)}$	5	A	
	$I_{F(Total)}$	10		
Non-Repetitive Peak Surge Current (Surge applied at rated load conditions halfwave, single phase, 60Hz)	I_{FSM}	150	A	
Maximum Instantaneous Forward Voltage @IF=5A, TC=25°C @IF=5A, TC=125°C	V_F	0.55	V	
		0.45		
Peak Reverse Current @Tc=25 °C at Rated DC Blocking Voltage @Tc=125°C	I_R	0.1	mA	
		6		
Operating and Storage Temperature Range	T_J, T_{STG}	-65 to +150	°C	
Maximum Thermal Resistance	θ_{JC}	T0-220	3	°C/W
		T0-220F	4.5	
	θ_{JA}	T0-220	60	
		T0-220F	60	



Characteristics Curves

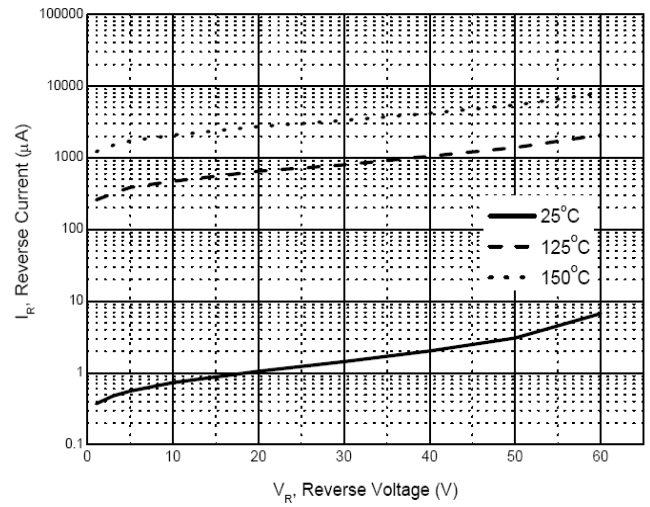
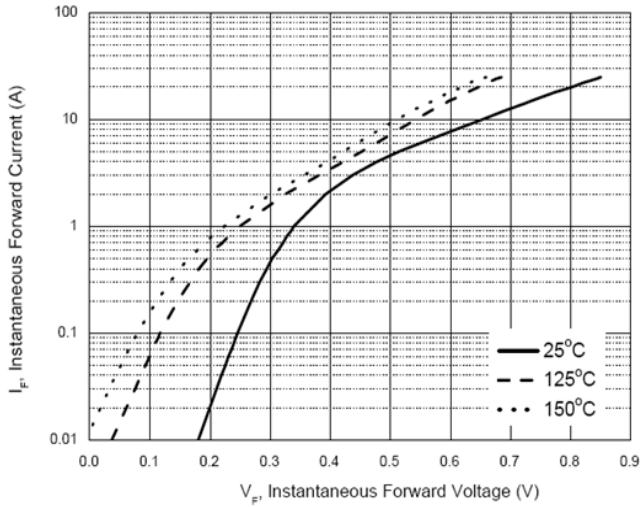

Typical Forward Voltage per Diode

Typical Reverse Current per Diode

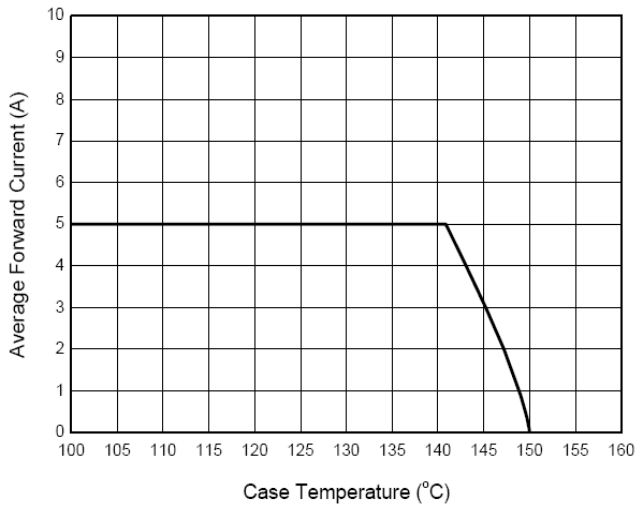

Average Forward Current vs. Case Temperature Per Diode



■ Reflow Soldering Temperature Profile

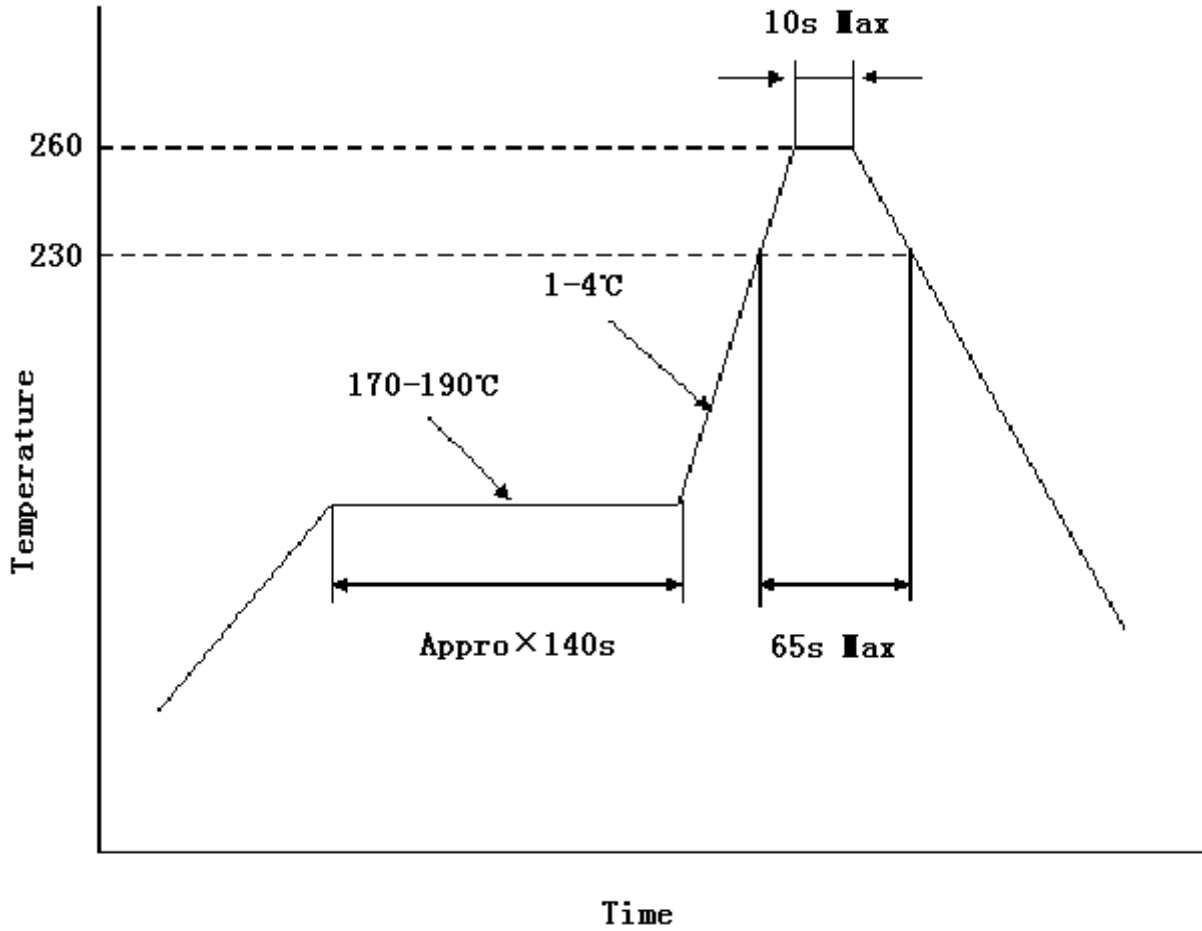



T0-220 MECHANICAL DATA

UNIT: mm

SYMBOL	MIN	NOM	MAX	SYMBOL	MIN	NOM	MAX
A	4		4.8	e	2.44	2.54	2.64
B	1.2		1.4	F	1.1		1.4
B1	1		1.4	L	12.5		14.5
b1	0.75		0.95	L1	3	3.5	4
c	0.4		0.55	ΦP	3.7	3.8	3.9
D	15		16.5	Q	2.5		3
D1	5.9		6.9	Q1	2		2.9
E	9.9		10.7				

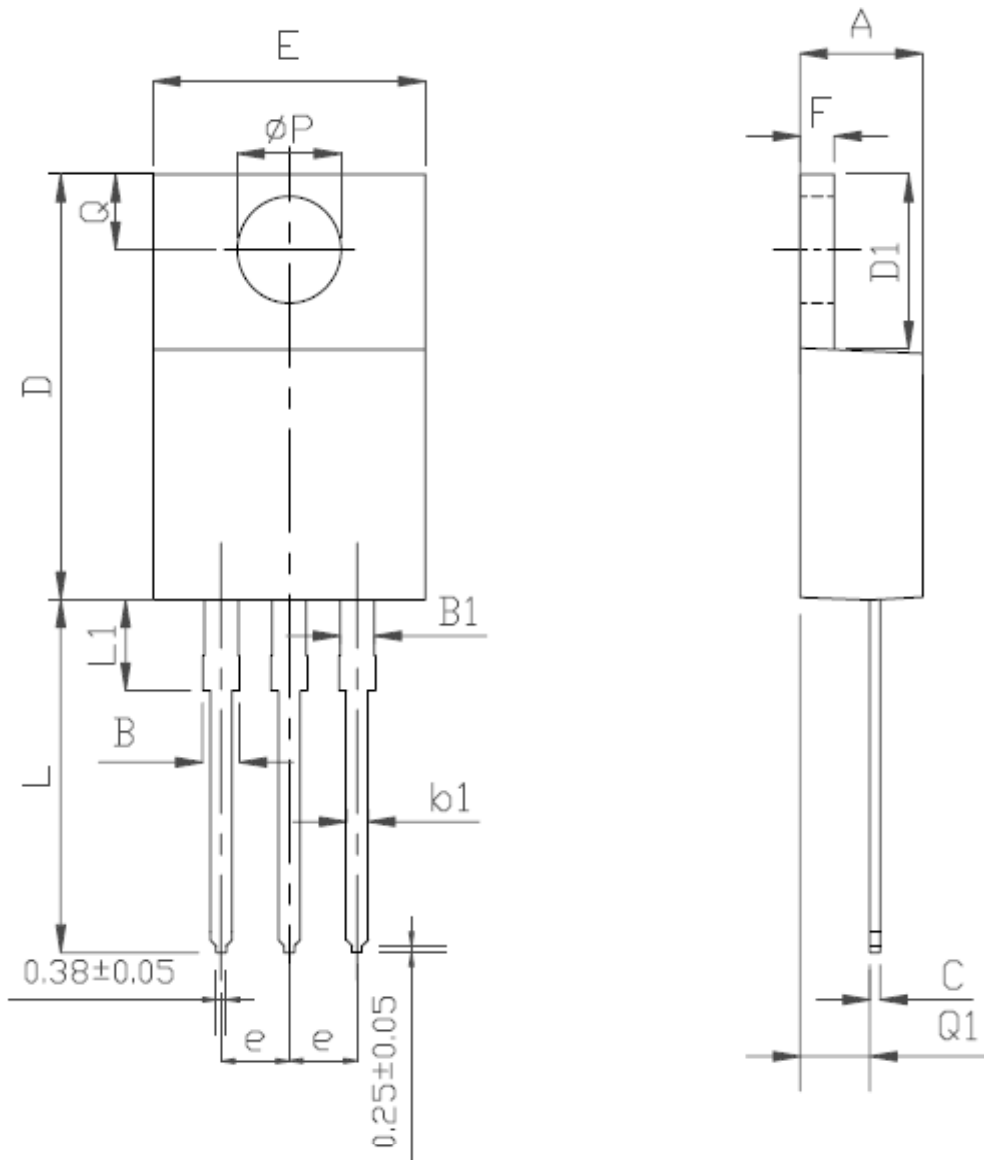



TO-220F MECHANICAL DATA

UNIT: mm

SYMBOL	MIN	NOM	MAX	SYMBOL	MIN	NOM	MAX
A	4.5		4.9	E1	6.5	7	7.5
A1	2.3		2.9	e	2.44	2.54	2.64
b	0.65		0.9	L	12.5		14.3
b1	1.1		1.7	L1	9.45		10.05
b2	1.2		1.4	L2	15		16
c	0.35		0.65	L3	3.2		4.4
D	14.5		16.5	ΦP	3		3.3
D1	6.1		6.9	Q	2.5		2.9
E	9.6		10.3				

